

# Agilent 8449A and 8449B Preamplifiers Operation and Service Manual

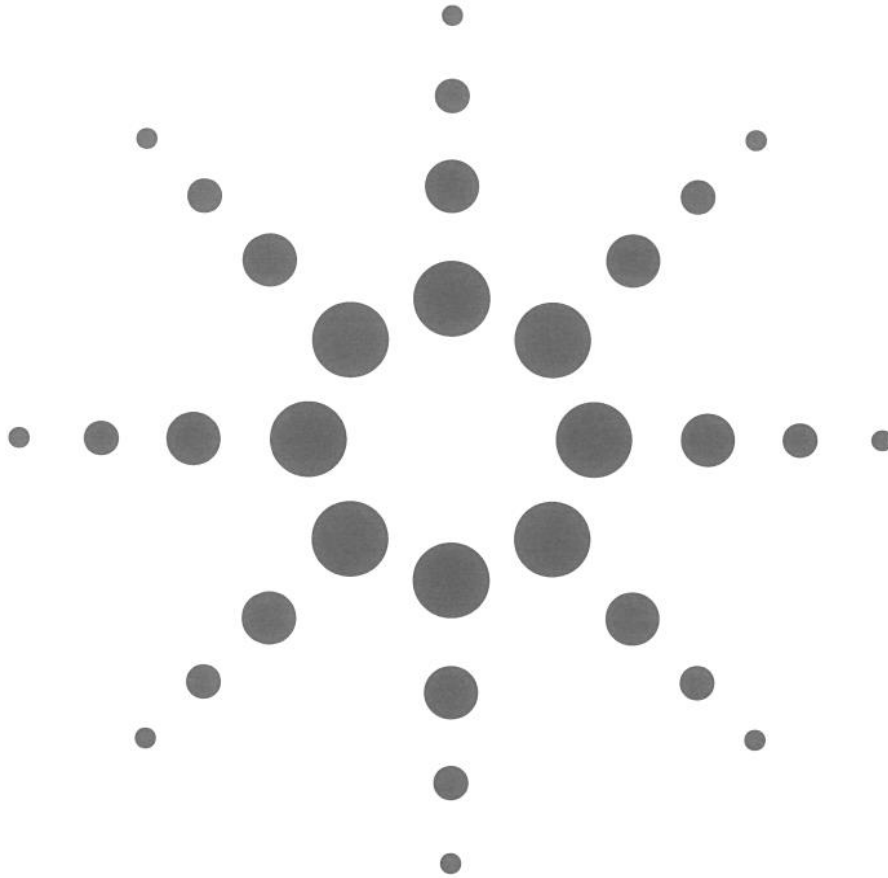



# Operation and Service Manual

**Agilent Technologies  
8449A and 8449B Preamplifiers**



**Agilent Technologies**

**Part Number: 08449-90011**

**Printed in USA**

**November 1990**

© Copyright 1990, 2002 Agilent Technologies, Inc.



# Notice

---

## Hewlett-Packard to Agilent Technologies Transition

This manual may contain references to HP or Hewlett-Packard. Please note that Hewlett-Packard's former test and measurement, semiconductor products and chemical analysis businesses are now part of Agilent Technologies. To reduce potential confusion, the only change to product numbers and names has been in the company name prefix: where a product name/number was HP XXXX the current name/number is now Agilent XXXX. For example, model number HP8648 is now model number Agilent 8648.

### Contacting Agilent Sales and Service Offices

The sales and service contact information in this manual may be out of date. The latest service and contact information for your location can be found on the Web at:

<http://www.agilent.com/find/assist>

If you do not have access to the Internet, contact your field engineer or the nearest sales and service office listed below. In any correspondence or telephone conversation, refer to your instrument by its model number and full serial number.

**United States**

(tel) 1 800 452 4844  
(fax) 1 800 829 4433

**Canada**

(tel) +1 877 894 4414  
(fax) +1 888 900 8921

**Europe**

(tel) (31 20) 547 2323  
(fax) (31 20) 547 2390

**Latin America**

(tel) (305) 269 7500  
(fax) (305) 269 7599

**Japan**

(tel) (81) 426 56 7832  
(fax) (81) 426 56 7840

**Australia**

(tel) 1 800 629 485  
(fax) (61 3) 9210 5947

**New Zealand**

(tel) 0 800 738 378  
(fax) 64 4 495 8950

**Asia Pacific**

(tel) (852) 3197 7777  
(fax) (852) 2506 9284



**Agilent Technologies**

©Copyright Hewlett-Packard Company 1990  
All Rights Reserved. Reproduction, adaptation, or translation without prior written  
permission is prohibited, except as allowed under the copyright laws.  
1212 Valley House Drive, Rohnert Park, CA 94928-4999, USA

---

## Certification

Hewlett-Packard Company certifies that this product met its published specifications at the time of shipment from the factory. Hewlett-Packard further certifies that its calibration measurements are traceable to the United States National Institute of Standards and Technology, to the extent allowed by the Institute's calibration facility, and to the calibration facilities of other International Standards Organization members.

---

## Warranty

This Hewlett-Packard instrument product is warranted against defects in material and workmanship for a period of one year from date of shipment. During the warranty period, Hewlett-Packard Company will, at its option, either repair or replace products which prove to be defective.

For warranty service or repair, this product must be returned to a service facility designated by HP. Buyer shall prepay shipping charges to HP and HP shall pay shipping charges to return the product to Buyer. However, Buyer shall pay all shipping charges, duties, and taxes for products returned to HP from another country.

HP warrants that its software and firmware designated by HP for use with an instrument will execute its programming instructions when properly installed on that instrument. HP does not warrant that the operation of the instrument, or software, or firmware will be uninterrupted or error-free.

## Limitation of Warranty

The foregoing warranty shall not apply to defects resulting from improper or inadequate maintenance by Buyer, Buyer-supplied software or interfacing, unauthorized modification or misuse, operation outside of the environmental specifications for the product, or improper site preparation or maintenance.

NO OTHER WARRANTY IS EXPRESSED OR IMPLIED. HP SPECIFICALLY DISCLAIMS THE IMPLIED WARRANTIES OF MERCHANTABILITY AND FITNESS FOR A PARTICULAR PURPOSE.

## Exclusive Remedies

THE REMEDIES PROVIDED HEREIN ARE BUYER'S SOLE AND EXCLUSIVE REMEDIES. HP SHALL NOT BE LIABLE FOR ANY DIRECT, INDIRECT, SPECIAL, INCIDENTAL, OR CONSEQUENTIAL DAMAGES, WHETHER BASED ON CONTRACT, TORT, OR ANY OTHER LEGAL THEORY.

---

## Assistance

*Product maintenance agreements and other customer assistance agreements are available for Hewlett-Packard products.*

*For any assistance, contact your nearest Hewlett-Packard Sales and Service Office.*

---

## Safety Symbols

The following safety symbols are used throughout this manual. Familiarize yourself with each of the symbols and its meaning before operating this instrument.

---

### Caution



The *caution* sign denotes a hazard. It calls attention to a procedure which, if not correctly performed or adhered to, could result in damage to or destruction of the instrument. Do not proceed beyond a *caution* sign until the indicated conditions are fully understood and met.

---

### Warning



The *warning* sign denotes a hazard. It calls attention to a procedure which, if not correctly performed or adhered to, could result in injury or loss of life. Do not proceed beyond a *warning* sign until the indicated conditions are fully understood and met.

---

---

## General Safety Considerations

### Warning



*Before this instrument is switched on, make sure it has been properly grounded through the protective conductor of the ac power cable to a socket outlet provided with protective earth contact.*

**Any interruption of the protective (grounding) conductor, inside or outside the instrument, or disconnection of the protective earth terminal can result in personal injury.**

---

### Warning



**There are many points in the instrument which can, if contacted, cause personal injury. Be extremely careful.**

**Any adjustments or service procedures that require operation of the instrument with protective covers removed should be performed only by trained service personnel.**

---

### Caution



*Before this instrument is switched on, make sure its primary power circuitry has been adapted to the voltage of the ac power source.*

**Failure to set the ac power input to the correct voltage could cause damage to the instrument when the ac power cable is plugged in.**

---



# Contents

---

|   |      |
|---|------|
| <b>1. General Information</b>                                   |      |
| Introduction . . . . .  | 1-1  |
| Manual Organization . . . . .                                   | 1-1  |
| Description of the HP 8449A and HP 8449B Preamplifier . . . . . | 1-2  |
| Safety Considerations . . . . .                                 | 1-3  |
| Electrostatic Discharge . . . . .                               | 1-3  |
| Reducing Damage Caused by ESD . . . . .                         | 1-4  |
| Static-Safe Accessories . . . . .                               | 1-4  |
| Serial Numbers . . . . .  | 1-6  |
| Serial Prefixes Covered by This Manual . . . . .                | 1-6  |
| Manual Updating Supplement . . . . .                            | 1-7  |
| Options Available . . . . .                                     | 1-7  |
| Specifications and Characteristics . . . . .                    | 1-7  |
| Typical System Performance . . . . .                            | 1-11 |
| <b>2. Preparation for Use</b>                                   |      |
| Introduction . . . . .  | 2-1  |
| Preparing the HP 8449A and HP 8449B for Use . . . . .           | 2-1  |
| Initial Inspection . . . . .                                    | 2-1  |
| Power Requirements . . . . .                                    | 2-1  |
| Setting the Line Voltage Selector Switch . . . . .              | 2-3  |
| Checking the Fuse . . . . .                                     | 2-3  |
| Power Cable . . . . .   | 2-4  |
| Turning On the HP 8449A or HP 8449B . . . . .                   | 2-6  |
| Verifying Proper Operation . . . . .                            | 2-6  |
| <b>3. Operation</b>   |      |
| Introduction . . . . .  | 3-1  |
| Panel Features . . . . .  | 3-1  |
| Front Panel . . . . .   | 3-1  |
| Rear Panel . . . . .  | 3-1  |
| Applications . . . . .  | 3-2  |
| Low-Level Signal Detection . . . . .                            | 3-3  |

|  |      |
|--|------|
| <b>4. Performance Tests</b>  |      |
| Introduction . . . . .   | 4-1  |
| Test Equipment You'll Need . . . . .   | 4-1  |
| Recording the Test Results . . . . .   | 4-1  |
| If the Preamplifier Doesn't Meet Specifications . . . . .                    | 4-1  |
| Verifying Operation . . . . .  | 4-2  |
| Gain and Flatness Test . . . . .   | 4-3  |
| Noise Figure Test . . . . .  | 4-5  |
| Alternate Noise Figure Test . . . . .  | 4-11 |
| <b>5. Replaceable Parts</b>  |      |
| Introduction . . . . .   | 5-1  |
| Parts List . . . . .   | 5-1  |
| Parts Ordering Information . . . . .   | 5-4  |
| Direct Mail Order System . . . . .   | 5-4  |
| Direct Phone Order System . . . . .  | 5-4  |
| <b>6. Service</b>  |      |
| Introduction . . . . .   | 6-1  |
| Check the Basics . . . . .   | 6-2  |
| General Troubleshooting . . . . .  | 6-2  |
| Testing the Amplifier . . . . .  | 6-3  |
| Testing and Adjusting the Power Supply . . . . .                             | 6-3  |
| General Maintenance . . . . .  | 6-4  |
| Required Tools . . . . .   | 6-4  |
| Removal and Replacement of Assemblies . . . . .                              | 6-4  |
| Returning Your HP 8449A or HP 8449B to Hewlett-Packard for Service . . . . . | 6-5  |
| Before You Call Hewlett-Packard . . . . .                                    | 6-5  |
| How to Call Hewlett-Packard . . . . .  | 6-5  |
| Service Tag . . . . .  | 6-5  |
| Original Packaging . . . . .   | 6-5  |
| Other Packaging . . . . .  | 6-6  |

## Figures

---

|  |      |
|--|------|
| 1-1. HP 8449A and HP 8449B Preamplifiers . . . . .                       | 1-2  |
| 1-2. Example of a Static-Safe Work Station . . . . .                     | 1-3  |
| 1-3. Typical Serial Number Label . . . . .                               | 1-6  |
| 2-1. HP 8449A and HP 8449B Shipping Container and Contents . . . . .     | 2-2  |
| 2-2. Setting the Voltage Selector Switch and Checking the Fuse . . . . . | 2-3  |
| 2-3. AC Power Cables Available . . . . .                                 | 2-5  |
| 3-1. HP 8449A and HP 8449B Front Panels . . . . .                        | 3-2  |
| 3-2. HP 8449A and HP 8449B, Typical Applications . . . . .               | 3-4  |
| 4-1. Gain and Flatness Test Setup . . . . .                              | 4-3  |
| 4-2. Noise Figure Test Setup Using an HP 8340A/B . . . . .               | 4-6  |
| 4-3. Alternate Noise Figure Test Setup for <2.5 GHz . . . . .            | 4-11 |
| 5-1. HP 8449A and HP 8449B Parts Locations . . . . .                     | 5-3  |
| 6-1. HP 8449A and HP 8449B Preamplifier, Block Diagram . . . . .         | 6-2  |

## Tables

---

|   |      |
|---|------|
| 1-1. Static-Safe Accessories . . . . .  | 1-5  |
| 1-2. HP 8449A Specifications and Characteristics . . . . .                                    | 1-8  |
| 1-3. HP 8449B Specifications and Characteristics . . . . .                                    | 1-10 |
| 1-4. Typical System Performance for HP 8449A or HP 8449B Added to Spectrum Analyzer . . . . . | 1-11 |
| 2-1. HP 8449A and HP 8449B Power Requirements . . . . .                                       | 2-1  |
| 3-1. Typical System Performance for HP 8449A or HP 8449B Added to Spectrum Analyzer . . . . . | 3-3  |
| 4-1. Recommended Test Equipment . . . . .   | 4-2  |
| 4-2. Performance Test Record . . . . .  | 4-15 |
| 6-1. Required Tools . . . . .   | 6-4  |
| 6-2. Torque Values . . . . .  | 6-5  |
| 6-3. Hewlett-Packard Sales and Service Offices . . . . .                                      | 6-7  |



## General Information

---

### Introduction

This manual provides the information you need to install, use, and maintain the HP 8449A and HP 8449B Preamplifiers.

---

### Manual Organization

- Chapter 1, “General Information,” describes the HP 8449A and HP 8449B and their specifications.
- Chapter 2, “Installation,” lists the steps necessary to unpack and prepare the HP 8449A and HP 8449B for use.
- Chapter 3, “Operation,” describes the typical applications for the HP 8449A and HP 8449B.
- Chapter 4, “Performance Tests,” contains the test procedures required to verify preamplifier specifications.
- Chapter 5, “Replaceable Parts,” contains the information necessary to order parts or assemblies for the preamplifier.
- Chapter 6, “Service,” contains troubleshooting and other information to aid in repair of the preamplifier, as well as instructions for making arrangements and packaging the unit for shipment to Hewlett-Packard.

---

## Description of the HP 8449A and HP 8449B Preamplifier

The HP 8449 Preamplifiers are low-noise, high-gain amplifiers that are connected between a signal source and the RF input of any spectrum analyzer. The combination of high gain and low noise figure enables the HP 8449A and HP 8449B to enhance analyzer performance by greatly reducing the overall system noise figure. This improved sensitivity allows detection and analysis of extremely low-level signals. The frequency range of the HP 8449A is 2.0 to 22.0 GHz. The frequency range of the HP 8449B is 1.0 to 26.5 GHz

The HP 8449A and HP 8449B are housed in compact, industry-standard, half-width System II packages that can be easily rack-mounted in traditional automatic test equipment (ATE) systems. See Figure 1-1.

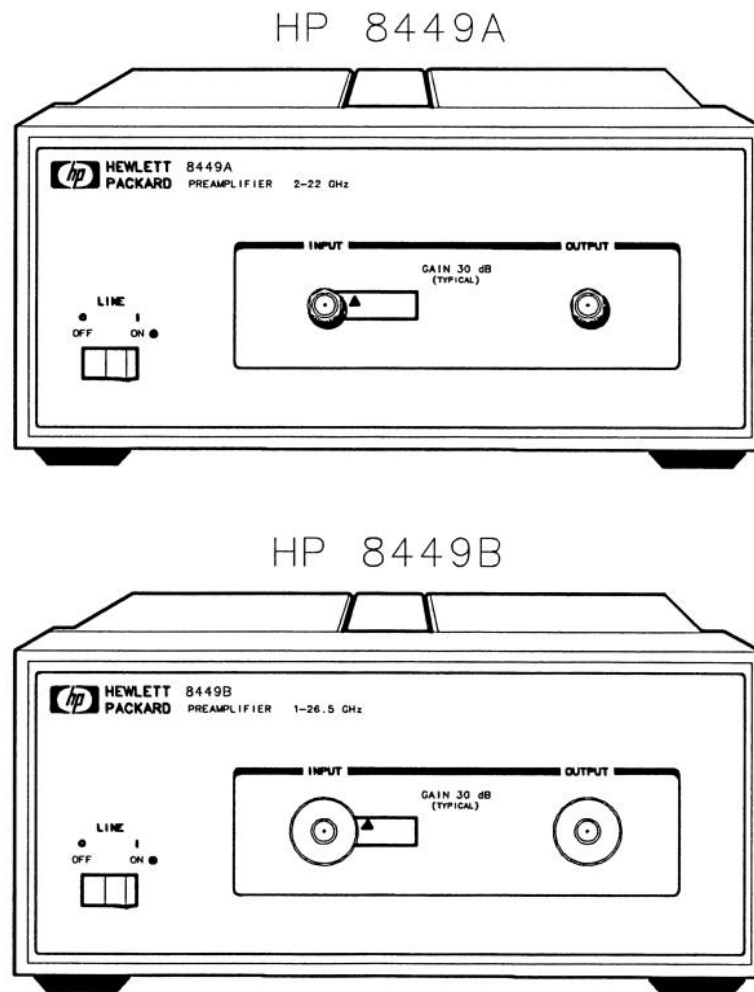

Figure 1-1. HP 8449A and HP 8449B Preamplifiers

---

## Safety Considerations

Before operating this instrument, read any safety markings on the instrument and the summary of safety information in the front of this manual.

Hewlett-Packard manufactures and tests the HP 8449A and HP 8449B to international safety standards. However, to ensure personal safety and prevent instrument damage, you must read and heed all cautions and warnings.

---

## Electrostatic Discharge

Electrostatic discharge (ESD) can damage or destroy electronic components. Therefore, all work performed on assemblies consisting of electronic components should be done at a static-free work station.

Figure 1-2 is an example of a static-safe work station using two types of ESD protection:

- Conductive table mat and wrist-strap combination.
- Conductive floor mat and heel-strap combination.

These methods may be used together or separately.

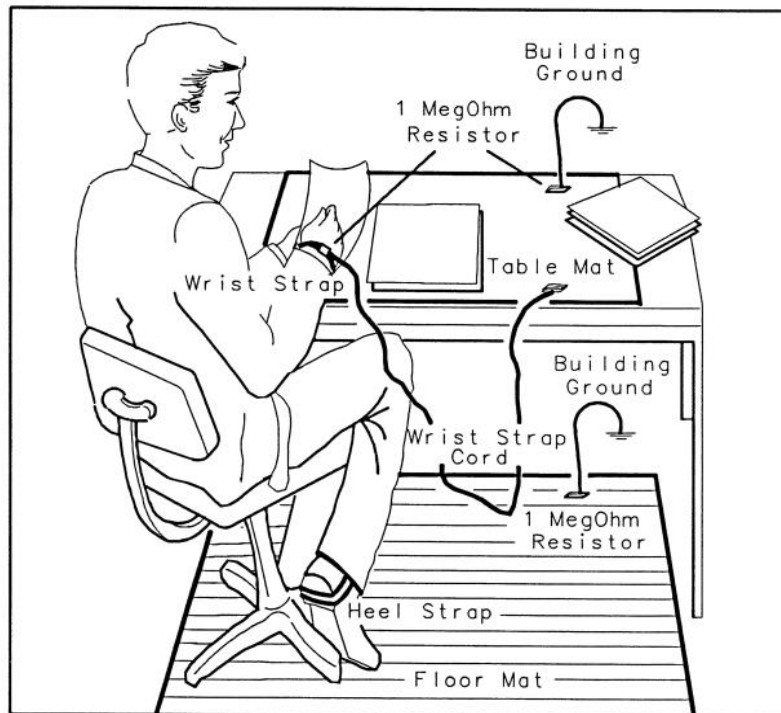

**Figure 1-2. Example of a Static-Safe Work Station**

## **Reducing Damage Caused by ESD**

The following are suggestions that may help reduce ESD damage that occurs during testing and servicing operations.

- Before connecting any coaxial cable to an analyzer connector for the first time each day, momentarily ground the center and outer conductors of the cable.
- Personnel should be grounded with a resistor-isolated wrist strap before touching the center pin of any connector and before removing any assembly from the unit.
- Be sure that all instruments are properly earth-grounded to prevent a buildup of static charge.

## **Static-Safe Accessories**

Table 1-1 lists static-safe accessories that can be obtained from Hewlett-Packard by using the HP part numbers shown.



**Table 1-1. Static-Safe Accessories**

| Accessory  | Description   | HP Part Number |
|--|---|----------------|
| Static-control mat and ground wire   | Set includes:<br><br>3M static-control mat, 0.6 m × 1.2 m (2 ft × 4 ft)<br><br>ground wire, 4.6 m (15 ft)<br>(The wrist strap and wrist-strap cord are <i>not</i> included. They must be ordered separately.) | 9300-0797      |
| Wrist-strap cord   | 1.5 m (5 ft)  | 9300-0980      |
| Wrist strap  | Black, stainless steel with four adjustable links and 7-mm post-type connector (The wrist-strap cord is <i>not</i> included.)   | 9300-1383      |
| ESD heel strap   | Reusable 6 to 12 months   | 9300-1169      |
| Hard-surface static-control mat*   | Large, black, 1.2 m × 1.5 m (4 ft × 5 ft)   | 92175A         |
|  | Small, black, 0.9 m × 1.2 m (3 ft × 4 ft)   | 92175C         |
| Soft-surface static-control mat*   | Brown, 1.2 m × 2.4 m (4 ft × 8 ft)  | 92175B         |
| Tabletop static-control mat*   | 58 cm × 76 cm (23 in × 30 in)   | 92175T         |
| Antistatic carpet*   | Small, 1.2 m × 1.8 m (4 ft × 6 ft)  |                |
|  | natural color   | 92176A         |
|  | russet color  | 92176C         |
|  | Large, 1.2 m × 2.4 m (4 ft × 8 ft)  |                |
|  | natural color   | 92176B         |
|  | russet color  | 92176D         |
| * These accessories can be ordered either through a Hewlett-Packard Sales Office or through HP DIRECT Phone Order Service. In the USA, the HP DIRECT phone number is (800) 538-8787. Contact your nearest Hewlett-Packard Sales Office for more information about HP DIRECT availability in other countries. |   |                |

---

## Serial Numbers

Hewlett-Packard makes frequent improvements to its products to enhance their performance, usability, or reliability, and to control costs. Hewlett-Packard service personnel have access to complete records of design changes to each type of equipment, based on the equipment's serial number. Whenever you contact Hewlett-Packard about your preamplifier, have the complete serial number available to make sure that you receive the most complete and accurate information possible.

See Figure 1-3. A two-part serial number appears on the mylar label attached to the rear panel of the preamplifier. The first four digits and the letter are the serial number prefix; the last five digits are the suffix. The prefix is the same for all identical preamplifiers, and changes only when a change is made to the preamplifier. The suffix is different for each preamplifier. Whenever you refer to the serial number, be sure to use the complete number, including the full prefix and suffix.

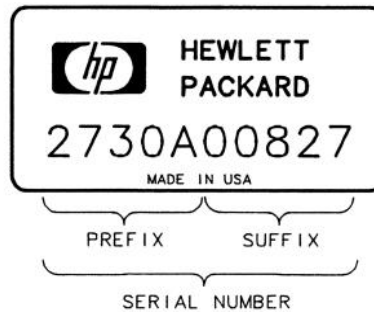

**Figure 1-3. Typical Serial Number Label**

### Serial Prefixes Covered by This Manual

| Model Number | Serial Number Prefix |
|--------------|----------------------|
| HP 8449A     | 3022A and higher     |
| HP 8449B     | 3008A and higher     |

---

## Manual Updating Supplement

A preamplifier manufactured after this manual has been printed may have a serial number prefix other than that listed on the title page, thus indicating a significant change. If a Manual Updating Supplement is included with the preamplifier, you should use the supplemental information to adapt this manual to the changed preamplifier. If there is no supplement, the manual requires no change.

Supplement information that corrects errors in the manual may apply to new or existing manuals. Therefore, you should periodically contact a Hewlett-Packard Sales and Service Office for the latest Manual Updating Supplement. The front cover of the supplement provides applicable model number, manual print date, and manual part number. For locations of Hewlett-Packard Sales and Service Offices, see Table 6-3.

---

## Options Available

### Option 907, Front Handle Kit

This kit provides front handles and the parts necessary for mounting them to the HP 8449A or HP 8449B Preamplifier.

### Option 908, Rack Mount Kit

This kit provides the parts necessary to mount the HP 8449A or HP 8449B Preamplifier in an HP System II cabinet or in a standard 19 inch (482.6 mm) equipment rack.

### Option 910, Extra Operation and Service Manual

---

## Specifications and Characteristics

- Specifications describe warranted performance over the temperature range 0°C to +55°C (unless otherwise noted). All specifications apply after the instrument's temperature has been stabilized after 1 hour continuous operation. Unless otherwise noted, corrected limits are given when specifications are subject to minimization with error-correction routines.
- *Characteristics* provide useful information by giving functional, but nonwarranted, performance parameters. *Characteristics are printed in italic font.*
- Typical Performance, where listed, is not warranted, but indicates performance which most units meet at 20°C to 30°C.
- Nominal Value indicates the expected, but not warranted, value of the parameter.

The HP 8449A specifications and characteristics are listed in Table 1-2. The HP 8449B specifications and characteristics are listed in Table 1-3.

**Table 1-2. HP 8449A Specifications and Characteristics**

| <b>FREQUENCY</b>  |  |
|---|--|
| <b>Frequency Range</b>  | 2.0 to 22.0 GHz  |
| <b>AMPLITUDE</b>  |  |
| <b>Flatness</b><br>2.0 to 22.0 GHz  | $\pm 3.8$ dB; $\pm 2.4$ dB Typical                                     |
| <b>Small Signal Gain</b><br>0°C to 55°C   | $\geq 23$ dB   |
| 20°C to 30°C  | $\geq 26$ dB; $\geq 30$ dB Typical                                     |
| <b>Noise Figure</b><br>2.0 to 22.0 GHz  | $\leq 12.5$ dB; $\leq 9.0$ dB Typical                                  |
| <i>Temperature Drift</i>  | $\leq -0.12$ dB per °C   |
| <i>Gain Compression</i>   | $\leq 1$ dB for output signal of +7 dBm                                |
| <i>Spectral Purity</i><br><i>Third Order Intercept</i><br><i>Measured at Amplifier</i><br><i>Output</i> | +15 dBm  |
| <i>Second Harmonic Intercept</i><br><i>Measured at Amplifier</i><br><i>Output</i>                       | $\geq +30$ dBm   |
| <i>Reverse Isolation</i>  | <i>Reduces spectrum analyzer local oscillator emissions &gt; 75 dB</i> |
| <b>INPUT AND OUTPUT</b>   |  |
| <b>Maximum Safe Power Input</b>   | +20 dBm (100 mW)   |
| <b>Maximum DC Input</b>   | $\pm 20$ V   |
| <i>Input and Output</i>   | <i>SMA, 50Ω nominal</i>  |
| <b>VSWR</b><br><i>Input</i><br>2.0 to 22.0 GHz  | $\leq 2.0:1$   |
| <i>Output</i><br>2.0 to 22.0 GHz  | $\leq 2.0:1$   |

**Table 1-2. HP 8449A Specifications and Characteristics**

| <b>GENERAL</b>   |   |
|--|---|
| <b>Power Requirements</b>  | 100, 120, 220, or 240 V ( $\pm 10\%$ ), 47 to 63 Hz   |
| <b>Temperature Range</b>   |   |
| Operation  | 0°C to +55°C  |
| Storage  | -40°C to +75°C  |
| <b>Environmental</b>   | Type tested per MIL-T-28800C, Type III, Class 5, Style E  |
| <b>EMI</b>   | Conducted and radiated emissions are in compliance with the requirements of FTZ 1046, CISPR Publication 11 (1975); and MIL-STD-461C, Part VII, Methods CE03 and RE02. |
| <b>Weight</b>  | 2.9 kg (6.4 lb)   |
| <b>Dimensions</b>  |   |
| <p>The diagram shows two views of the HP 8449A instrument. On the left is the 'REAR' view, which is a rectangle with a width dimension of 213mm (8.4 in.) and a height dimension of 102mm (4.0 in.). On the right is the 'SIDE' view, which is a longer rectangle with a length dimension of 297mm (11.74 in.) and a height dimension of 102mm (4.0 in.). Both views show the instrument sitting on four small feet.</p> |   |

**Table 1-3. HP 8449B Specifications and Characteristics**

| <b>FREQUENCY</b>  |   |                              |
|---|---|------------------------------|
| <b>Frequency Range</b>  | 1.0 to 26.5 GHz   |                              |
| <b>AMPLITUDE</b>  |   |                              |
| <b>Flatness</b>   |   |                              |
| 1.0 to 26.5 GHz   | ±5.7 dB   |                              |
| 2.0 to 22.0 GHz   | ±2.4 dB, Typical  |                              |
| <b>Small Signal Gain</b>  |   |                              |
| 0°C to 55°C   | ≥23 dB  |                              |
| 20°C to 30°C  | ≥26 dB  |                              |
| <b>Noise Figure</b>   |   |                              |
|   | <b>0°C to 55°C</b>  | <b>20°C to 30°C, Typical</b> |
| 1.0 to 12.5 GHz   | ≤8.5 dB   | ≤7.0 dB                      |
| 12.5 to 22.0 GHz  | ≤12.5 dB  | ≤9.0 dB                      |
| 22.0 to 26.5 GHz  | ≤14.5 dB  | ≤12.0 dB                     |
| <i>Temperature Drift</i>  | ≤−0.12 dB per °C  |                              |
| <i>Gain Compression</i>   | < 1 dB for output signal of ≤+7 dBm                         |                              |
| <i>Spectral Purity</i>  |   |                              |
| <i>Third Order Intercept<br/>Measured at Amplifier<br/>Output</i>     | +15 dBm   |                              |
| <i>Second Harmonic Intercept<br/>Measured at Amplifier<br/>Output</i> | ≥+30 dBm  |                              |
| <i>Reverse Isolation</i>  | Reduces spectrum analyzer local oscillator emissions >75 dB |                              |
| <b>INPUT AND OUTPUT</b>   |   |                              |
| <b>Maximum Safe Power Input</b>                                       | +20 dBm (100 mW)  |                              |
| <b>Maximum DC Input</b>   | ±20 V   |                              |
| <i>Input and Output</i>   | SMA, 50Ω nominal  |                              |
| <i>VSWR</i>   |   |                              |
| <i>Input</i>  |   |                              |
| 1.0 to 26.5 GHz   | ≤2.0:1  |                              |
| 2.0 to 12.5 GHz   | ≤1.5:1  |                              |
| <i>Output</i>   |   |                              |
| 1.0 to 26.5 GHz   | ≤2.0:1  |                              |

**Table 1-3. HP 8449B Specifications and Characteristics**

| <b>GENERAL</b>            |   |
|---------------------------|---|
| <b>Power Requirements</b> | 100, 120, 220, or 240 V ( $\pm 10\%$ ), 47 to 63 Hz   |
| <b>Temperature Range</b>  |   |
| Operation                 | 0°C to +55°C  |
| Storage                   | -40°C to +75°C  |
| <b>Environmental</b>      | Type tested per MIL-T-28800C, Type III, Class 5, Style E  |
| <b>EMI</b>                | Conducted and radiated emissions are in compliance with the requirements of FTZ 1046, CISPR Publication 11 (1975); and MIL-STD-461C, Part VII, Methods CE03 and RE02. |
| <b>Weight</b>             | 2.9 kg (6.4 lb)   |
| <b>Dimensions</b>         |   |

The drawing shows two views of the HP 8449B. The rear view on the left is a rectangle with a width dimension of 213mm (8.4 in.) and a height dimension of 102mm (4.0 in.). The side view on the right is a rectangle with a length dimension of 297mm (11.74 in.) and a height dimension of 102mm (4.0 in.). Both views show the device sitting on four small feet.

## Typical System Performance

Table 1-4 lists typical system displayed average noise levels for the HP 8566B and HP 8563A Spectrum Analyzers when used with the HP 8449A or 8449B Preamplifiers.

**Table 1-4.**  
**Typical System Performance for HP 8449A or HP 8449B**  
**Added to Spectrum Analyzer**

| Frequency | Displayed Average Noise Level (dBm)* |                             |
|-----------|--------------------------------------|-----------------------------|
|           | HP 8566B<br>(10 Hz Res BW)           | HP 8563A<br>(100 Hz Res BW) |
| 2 GHz     | -155                                 | -153                        |
| 4 GHz     | -154                                 | -154                        |
| 8 GHz     | -150                                 | -146                        |
| 16 GHz    | -144                                 | -141                        |
| 22 GHz    | -140                                 | -136                        |

\* Note: all values at 20 to 30°C.





## Preparation for Use

---

### Introduction

This chapter includes initial inspection procedures, setting up the unit for the ac power source, and verifying that the unit is operating correctly.

---

### Preparing the HP 8449A and HP 8449B for Use

#### Initial Inspection

Inspect the preamplifier's shipping container for damage. If the shipping container or cushioning material is damaged, keep it until you have verified that the contents are complete and you have tested the preamplifier mechanically and electrically.

The shipping container and packaging material are shown in Figure 2-1. If the contents are incomplete or if the preamplifier does not pass the performance tests (procedures are contained in Chapter 4) notify the nearest HP office. If the shipping container is damaged or the cushioning material shows signs of stress, notify the carrier. Keep the shipping materials for the carrier's inspection. The HP office will arrange for repair or replacement without waiting for a claim settlement.

If the shipping container and cushioning material are in good condition, retain them for possible future use. You may wish to ship the preamplifier to another location or to return it to Hewlett-Packard for service. Chapter 6 provides instructions for repackaging and shipping the preamplifier.

#### Power Requirements

**Table 2-1. HP 8449A and HP 8449B Power Requirements**

| Characteristic | Requirement                            |
|----------------|--|
| Input Voltage  | 100, 120, 220, or 240 V ( $\pm 10\%$ ) |
| Frequency      | 47 to 63 Hz                            |
| Power          | 75 VA (max)                            |

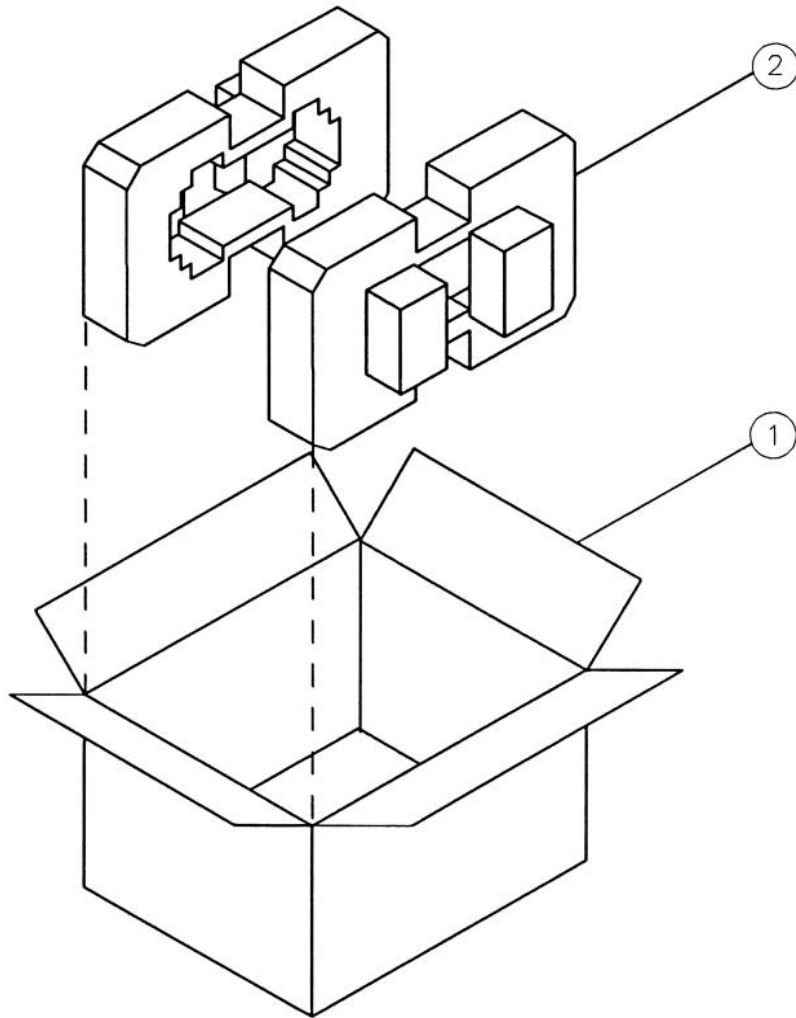

| ITEM | QTY | HP PART NO. | DESCRIPTION  |
|------|-----|-------------|--------------|
| ①    | 1   | 9211-4870   | CARTON-OUTER |
| ②    | 2   | 11975-80003 | FOAM PADS    |
|      | 1   | 9222-1119   | PLASTIC BAG  |

**Figure 2-1. HP 8449A and HP 8449B Shipping Container and Contents**

**2-2 Preparation for Use**

## Setting the Line Voltage Selector Switch

### Caution



Before connecting the HP 8449A or HP 8449B to the power source, you must set the rear-panel voltage selector switch correctly to adapt the HP 8449A or HP 8449B to the power source. An improper selector switch setting can damage the unit when it is turned on.

The voltage selector switch is located in the ac power module on the rear panel of the preamplifier. The selected voltage range (100 to 120 V, or 220 to 240 V) is visible through the small “window.” See Figure 2-2. To change the voltage, gently pry open one end of the fuse-holder door using a small screwdriver or similar tool. Remove the voltage-selection “drum” from the assembly. Rotate the voltage-selection drum and reinstall it so that the proper voltage label is visible through the window. Check the line fuse before closing the fuse-holder door.

## Checking the Fuse

### Note



The ac line input fuse is the same value regardless of the input line voltage. It is rated at 0.5 A, 250 V. Its HP part number is 2110-0202.

The line fuse is housed in a small container in the rear-panel ac power module. See Figure 2-2. To check the fuse, slide the fuse holder out of the module after opening the fuse-holder door. If the fuse is defective or missing, install a new fuse in the fuse holder and reinsert the fuse holder. Close the fuse-holder door.

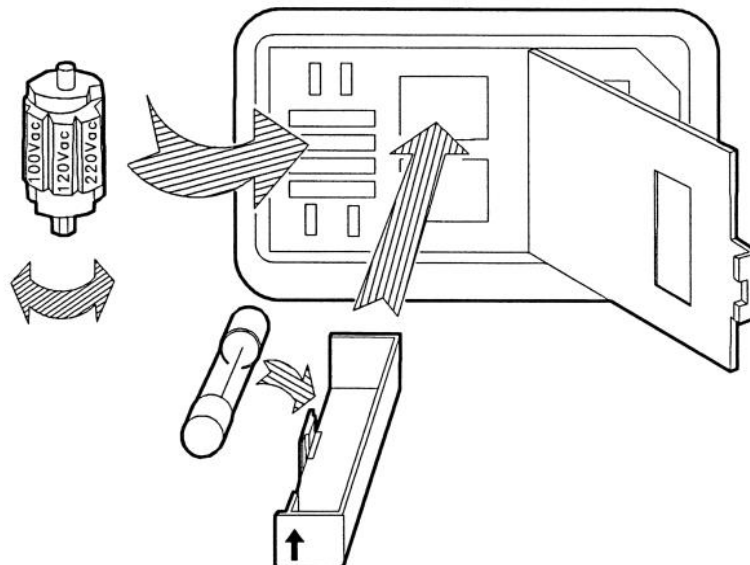

Figure 2-2. Setting the Voltage Selector Switch and Checking the Fuse

## Power Cable

The HP 8449A and HP 8449B are equipped with a three-wire power cable, in accordance with international safety standards. When connected to an appropriate power line outlet, this cable grounds the preamplifier chassis.

---

### Warning



**Failure to ground the preamplifier properly can result in personal injury or death.**

**Before turning on the HP 8449A or HP 8449B, you must connect its protective earth terminals to the protective conductor of the main power cable. Insert the main power cable plug only into a socket outlet that has a protective earth contact.**

***Do not defeat the earth-grounding protection by using an extension cable, power cable, or autotransformer without a protective ground conductor. If you are using an autotransformer, make sure its common terminal is connected to the protective earth contact of the power source outlet socket.***

---

Various power cables are available to connect the HP 8449A and HP 8449B to the types of ac power outlets unique to specific geographic areas. The cable appropriate for the area to which the preamplifier is originally shipped is included with the unit. You can order additional ac power cables for use in different areas. Figure 2-3 lists the available ac power cables, illustrates the plug configurations, and identifies the geographic area in which each cable is appropriate.







| PLUG TYPE *   | CABLE HP PART NUMBER                | PLUG DESCRIPTION                                  | CABLE LENGTH CM (INCHES)        | CABLE COLOR                         | FOR USE IN COUNTRY  |
|---|-------------------------------------|---|---------------------------------|-------------------------------------|---|
| 250V<br>   | 8120-1351<br>8120-1703              | Straight**BS1363A<br>90°                          | 229 (90)<br>229 (90)            | Mint Gray<br>Mint Gray              | Great Britain,<br>Cyprus, Nigeria,<br>Rhodesia,<br>Singapore,<br>So.Africa, India                     |
| 250V<br>   | 8120-1369<br>8120-0696              | Straight**NZSS198/ASC112<br>90°                   | 201 (79)<br>221 (87)            | Gray<br>Gray                        | Australia,<br>New Zealand   |
| 250V<br>   | 8120-1689<br>8120-1692              | Straight**CEE7-Y11<br>90°                         | 201 (79)<br>201 (79)            | Mint Gray<br>Mint Gray              | East and West<br>Europe, Saudi<br>Arabia, United<br>Arab Republic<br>(unpolarized in<br>many nations) |
| 125V<br>  | 8120-1348                           | Straight**NEMA5-15P                               | 203 (80)                        | Black                               | United States<br>Canada,<br>Japan (100 V or<br>200 V),<br>Mexico,<br>Phillipines,<br>Taiwan           |
|   | 8120-1398                           | Straight**NEMA5-15P                               | 203 (80)                        | Black                               |   |
|   | 8120-1754                           | Straight**NEMA5-15P                               | 91 (36)                         | Black                               |   |
|   | 8120-1378<br>8120-1521<br>8120-1676 | Straight**NEMA5-15P<br>90°<br>Straight**NEMA5-15P | 203 (80)<br>203 (80)<br>91 (36) | Jade Gray<br>Jade Gray<br>Jade Gray |   |
| 250V<br>   | 8120-2104                           | Straight**SEV1011<br>1959-24507<br>Type 12        | 201 (79)                        | Gray                                | Switzerland   |
| 220V<br>   | 8120-0698                           | Straight**NEMA6-15P                               |                                 |                                     |   |
| 250V<br>   | 8120-1860                           | Straight**CEEE22-VI                               |                                 |                                     |   |
| <p>* E = Earth Ground; L = Line; N = Neutral.<br/> ** Part number for plug is industry identifier for plug only. Number shown for cable is HP Part Number for complete cable, including plug.</p> |                                     |   |                                 |                                     |   |

Figure 2-3. AC Power Cables Available

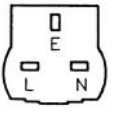
---

## **Turning On the HP 8449A or HP 8449B**

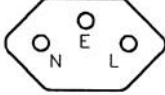
The LINE switch in the lower left-hand corner of the front-panel turns on the preamplifier. The green LED is lit when power is applied.

---

## **Verifying Proper Operation**

Before using the HP 8449A or HP 8449B, verify that it is performing within its specifications. Perform the performance tests (Gain and Flatness, and Noise Figure) given in Chapter 4. Record the results in Table 4-2 for future reference.

## Operation

---

### Introduction

This chapter provides information that will enable you to use the HP 8449A or HP 8449B Preamplifier effectively in a variety of applications.

---

### Panel Features

The preamplifier's front- and rear-panel controls and connectors are described in the following paragraphs. Figure 3-1 illustrates the front panel.

#### Front Panel

|             |   |
|-------------|---|
| LINE OFF-ON | AC line switch. The switch turns the instrument primary power on and off. The green LED is lit when power is on.  |
| INPUT       | SMA (f) connector for HP 8449A, or APC 3.5 (m) for HP 8449B to apply an RF input to the preamplifier. Refer to Table 1-2, Specifications and Characteristics, for detailed information. |

---

#### Caution



The amplifier input is sensitive to static electricity. Always ground the external cable before connecting it. Also read the electrostatic discharge information in Chapter 1 and follow the recommendations provided.

---

|        |  |
|--------|--|
| OUTPUT | SMA (f) connector for HP 8449A, or APC 3.5 (m) for 8449B to apply the amplified RF output from the preamplifier. Refer to Table 1-2, Specifications and Characteristics, for detailed information. |
|--------|--|

#### Rear Panel

|                 |  |
|-----------------|--|
| AC Power Module | Contains three-wire ac power receptacle, line voltage (100, 120, 220, or 240 volts) selector, and line fuse. |
|-----------------|--|

HP 8449A

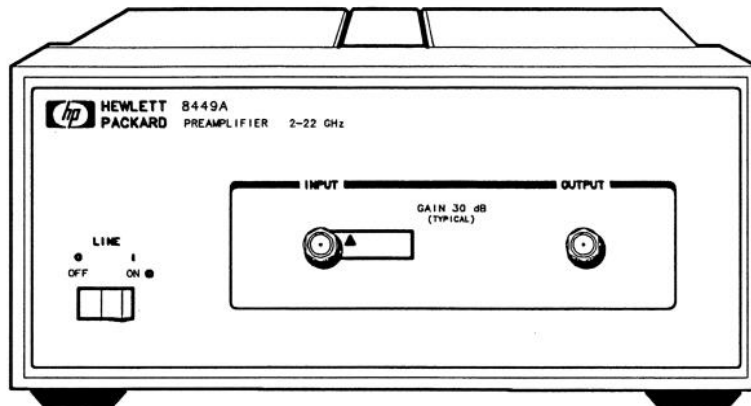

HP 8449B

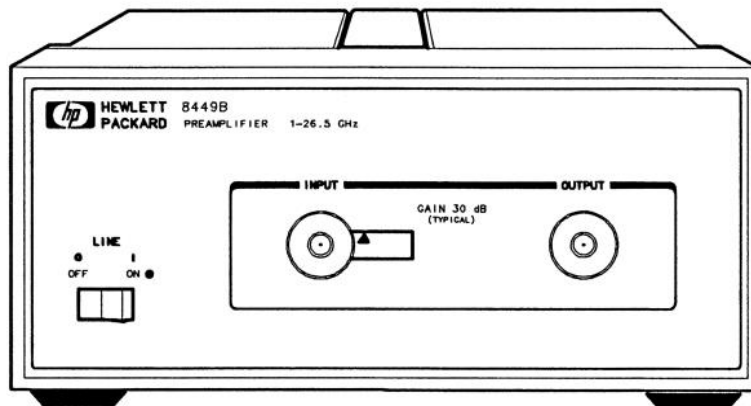

Figure 3-1. HP 8449A and HP 8449B Front Panels

---

## Applications

The HP 8449A or HP 8449B can be added to any microwave spectrum analyzer system or used in any application in which additional gain and low noise are required. Table Table 3-1 lists typical system displayed average noise levels for the HP 8566B and HP 8563A spectrum analyzers when used with the HP 8449A and HP 8449B Preamplifier. The following section and Figure 3-2 describe a typical application.



**Table 3-1.**  
**Typical System Performance for HP 8449A or HP 8449B**  
**Added to Spectrum Analyzer**

| Frequency                         | Displayed Average Noise Level (dBm)* |                             |
|-----------------------------------|--------------------------------------|-----------------------------|
|                                   | HP 8566B<br>(10 Hz Res BW)           | HP 8563A<br>(100 Hz Res BW) |
| 2 GHz                             | -155                                 | -153                        |
| 4 GHz                             | -154                                 | -154                        |
| 8 GHz                             | -150                                 | -146                        |
| 16 GHz                            | -144                                 | -141                        |
| 22 GHz                            | -140                                 | -136                        |
| * Note: all values at 20 to 30°C. |                                      |                             |

### Low-Level Signal Detection

Detection of low-level signals normally requires the use of very narrow spectrum analyzer bandwidths to obtain the necessary sensitivity. As the bandwidth is narrowed, sweep times become longer and measurement speed is reduced. The analyzer noise level is lowered by reducing the resolution bandwidth (RBW); the noise level decreases 10 dB per decade of change in resolution bandwidth. Sweep time is inversely proportional to the **square** of the RBW.

For example, if the RBW were decreased by a factor of 10, the sweep time increases by a factor of 100.

The improved sensitivity provided by the addition of the HP 8449A or HP 8449B allows you to widen the bandwidth and measure low-level signals using much shorter sweep times.

This increased sensitivity makes the HP 8449A and HP 8449B especially useful in measuring spurious emissions (spur searching). Typical spur specifications for devices vary from -60 dBc to less than -100 dBc (dB below carrier). This means that the spectrum analyzer must have excellent sensitivity to be able to measure low-level products. In many applications, addition of the HP 8449A or HP 8449B enables you to detect lower-level spurs without significantly narrowing the bandwidth, thereby speeding up the spur-search process.

---

#### Note



Spur searches are normally conducted in proximity to a relatively high-level carrier signal. Use caution to avoid overloading the preamplifier.

---

#### Note



If you are using a spectrum analyzer that has a reference-level offset capability, you can enter the preamplifier's gain (in dB) into the spectrum analyzer's memory so that the true signal level is measured directly on the display.

---

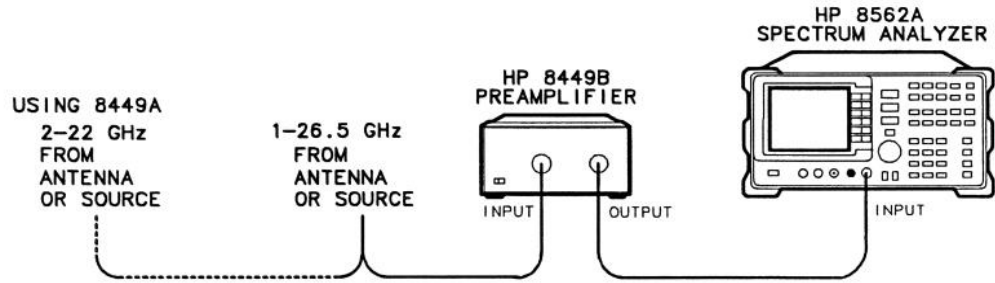

**Figure 3-2. HP 8449A and HP 8449B, Typical Applications**

## Performance Tests

---

### Introduction

This chapter provides instructions for testing the performance of the HP 8449A and HP 8449B Preamplifiers. Performance tests are used to check the instrument when it is initially received and periodically thereafter. The tests verify the specifications listed in Table 1-2 and Table 1-3.

---

### Test Equipment You'll Need

Required test equipment is listed in Table 4-1 and at the beginning of each test procedure. Test instruments other than those listed may be used, provided their performance equals or exceeds the critical specifications listed in Table 4-1.

---

### Recording the Test Results

A Performance Test Record form is provided as Table 4-2 at the end of the chapter. We recommend that you make a copy of this table, record the complete test results on the copy, and keep the copy for your calibration test record. This record could prove valuable in tracking gradual changes in test results over long periods of time.

---

### If the Preamplifier Doesn't Meet Specifications

If the preamplifier doesn't meet one or more of the specifications, complete any remaining tests and record all test results on a copy of the Performance Test Record. Then refer to Chapter 6, "Service," for instructions on how to solve the problem.

## Verifying Operation

Under most conditions of use, you should test the preamplifier every 2 years with the performance tests to verify that it is performing within its specifications.

**Table 4-1. Recommended Test Equipment**

| Instrument                   | Critical Specification  | Recommended Model           |
|------------------------------|---|-----------------------------|
| Noise Source                 | Frequency Range: 1.0 to 26.5 GHz  | HP 346C                     |
| Synthesized Sweeper          | Frequency Range: 10 MHz to 26.5 GHz<br>Output Power: -30 dBm to +5 dBm (leveled)<br>Aging Rate: $<10^{-9}$ /day | HP 8340A or<br>HP 8340B     |
| Synthesized Signal Generator | Frequency Range: 1 MHz to 2560 MHz  | HP 8663A                    |
| Scalar Network Analyzer      | Frequency Range: 10 MHz to 26.5 GHz<br>Only scalar functions required.  | HP 8757A                    |
| Preamplifier                 | 1.0 to 26.5 GHz<br>$\geq 10$ dB Gain<br>+10 dBm Out at 26.5 GHz   | HP 8449B                    |
| Noise Figure Meter           | Noise Figure Range: 5 to 30 dB  | HP 8970A or<br>HP 8970B     |
| Detector (2)                 | Frequency Range: 10 MHz to 26.5 GHz<br>Return Loss: 10 dB   | HP 11664E                   |
| Power Splitter               | Frequency Range: 10 MHz to 26.5 GHz   | HP 11667B                   |
| Mixer                        | Frequency Range: 1.0 to 26.0 GHz<br>$\leq 9.5$ dB Conversion Loss<br>VSWR $\leq 4:1$                            | HP part number<br>0955-0307 |
| Mixer                        | Frequency Range: 1.0 to 3.0 GHz<br>$\leq 8$ dB Conversion Loss<br>VSWR $\leq 3:1$                               | Mini-Circuits<br>ZFM-15     |
| 10 dB Attenuator             | —   | HP 33340C                   |
| Adapter                      | APC 3.5 (m) to APC 3.5 (m)  | 1250-1748                   |
| Adapter (3 required)         | APC 3.5 (f) to APC 3.5 (f)  | 5061-5311                   |
| Adapter                      | APC 3.5 (f) to N (m)  | 1250-1744                   |

## Gain and Flatness Test

### Description

This test measures the gain and flatness of the preamplifier over its frequency range. First, the synthesized sweeper and scalar network analyzer are connected without the preamplifier in the circuit in order to establish a reference level. The preamplifier is then added to the circuit and the gain is compared to the original reference level. The flatness is measured as the change in gain across the frequency range. The test setup is illustrated in Figure 4-1.

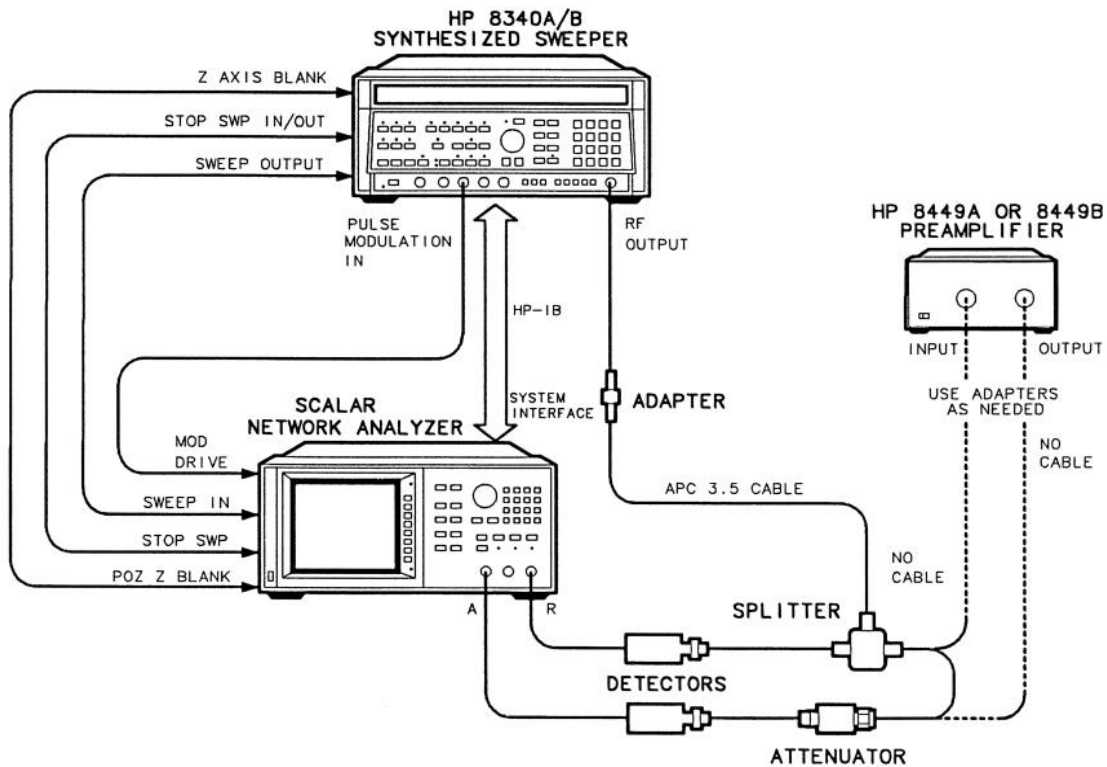

Figure 4-1. Gain and Flatness Test Setup

### Equipment

|                                      |            |
|--------------------------------------|------------|
| Synthesized Sweeper .....            | HP 8340A/B |
| Scalar Network Analyzer .....        | HP 8757A   |
| Detector ( <i>2 required</i> ) ..... | HP 11664E  |
| Power Splitter .....                 | HP 11667B  |
| 10 dB Attenuator .....               | HP 33340C  |

### Adapters

|  |           |
|--|-----------|
| APC 3.5 (m) to APC 3.5 (m) .....                       | 1250-1748 |
| APC 3.5 (f) to APC 3.5 (f) ( <i>3 required</i> ) ..... | 5061-5311 |

## Gain and Flatness Test

### Procedure

1. Connect the test equipment as shown by the solid lines in Figure 4-1 (no connections are made to the preamplifier at this time).
2. On the network analyzer, press **PRESET**.
3. Set the synthesized sweeper as follows:

- a. For testing the HP 8449A:

START ..... 2 GHz  
STOP ..... 22 GHz  
POWER LEVEL ..... -30 dBm

- b. For testing the HP 8449B:

START ..... 1 GHz  
STOP ..... 26.5 GHz  
POWER LEVEL ..... -30 dBm

4. On the network analyzer, set up the reference level as follows:

MEAS ..... A/R  
CAL ..... THRU

When the prompt **CONNECT THRU ... STORE WHEN READY** appears, press:

STOR THRU  
DISPLAY ..... MEAS - MEM  
SCALE ..... 10 dB/div

5. Connect preamplifier to test equipment as shown by dashed lines in Figure 4-1:
  - a. Disconnect the attenuator from the R port of the splitter and connect it directly to the preamplifier **OUTPUT** port.
  - b. Connect the R port of the splitter directly to the preamplifier **INPUT** port.
6. On the network analyzer:

SCALE ..... AUTO SCALE  
AVG ..... AVG ON  
CURSOR ..... MIN

Read and record the indicated minimum gain in Table 4-2.

CURSOR  $\Delta$  ON  
MAX

Read and record the indicated flatness in Table 4-2.

---

## Noise Figure Test

Using an HP 8340A/B Synthesized Sweeper

### Description

This test measures the noise figure of the preamplifier over its frequency range. First, the source and noise figure meter are connected to calibrate the test setup without the preamplifier in the circuit. The preamplifier is then added to the circuit and the noise figure is measured. The test setup is illustrated in Figure 4-2.

---

### Note



During the test-setup calibration, you may encounter Error 27 (E27) on the HP 8970A/B Noise Figure Meter. This is a warning message at this point. Actual testing may run smoothly.

If, however, after the preamplifier is connected in the circuit and testing begins, and E22 occurs, one of two conditions may exist:

- a. If you are testing the preamplifier below 2.5 GHz, there may be too much accumulated low frequency noise for testing the preamplifier with the HP 8340A/B. Use the Alternate Noise Figure Test that follows this procedure for testing frequency ranges below 2.5 GHz.
- b. If E22 occurs while testing the preamplifier at frequencies above 2.5 GHz, the test setup mixer is malfunctioning. You can try increasing the source output power into the mixer, attempting the test again, or try replacing the mixer and retesting.

---

### Caution



The external mixer used in this procedure is extremely static sensitive. Use extreme caution when handling this device. Regular replacement is recommended.

---

## Noise Figure Test

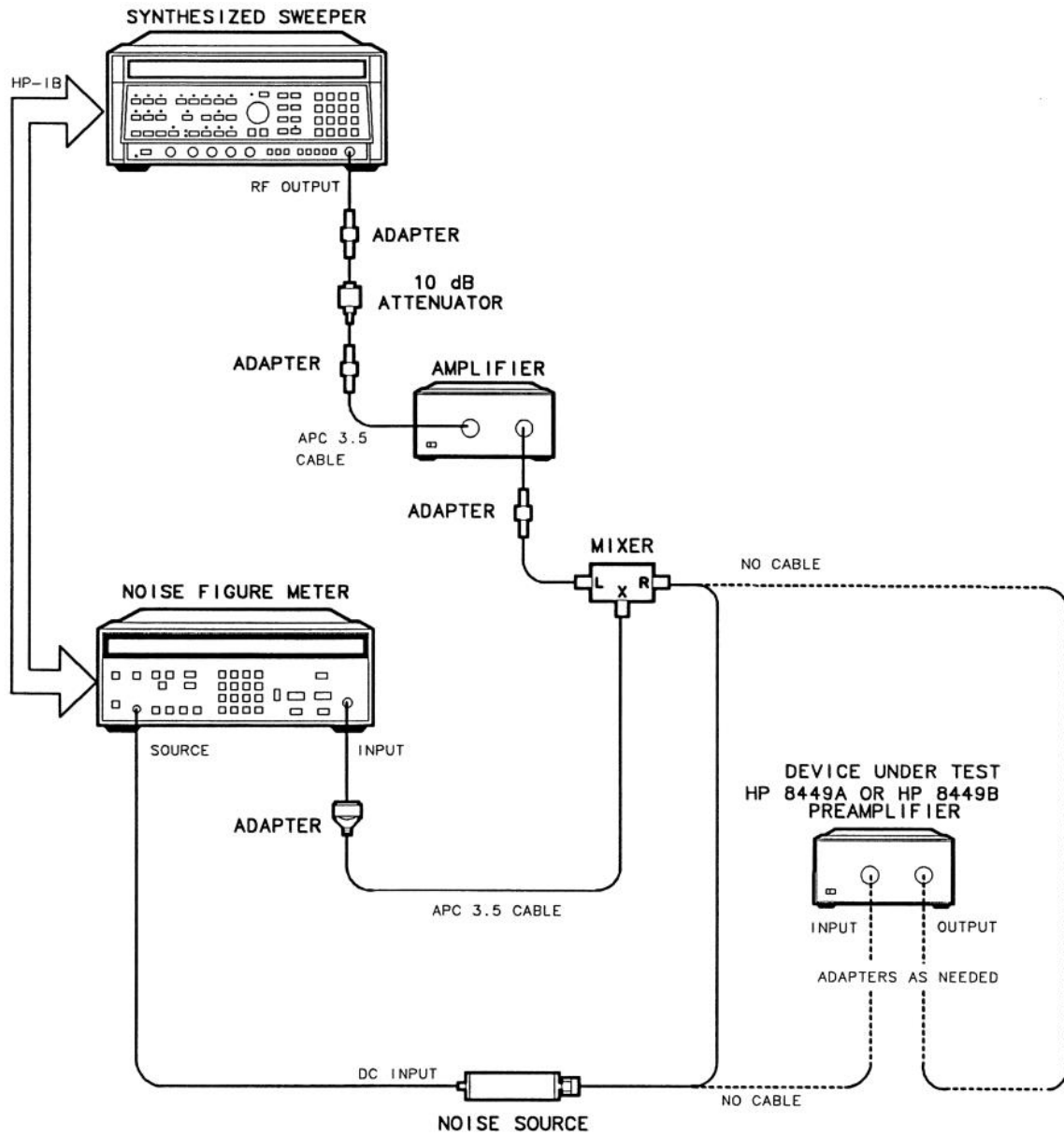

Figure 4-2. Noise Figure Test Setup Using an HP 8340A/B

### Recommended Equipment

|                           |            |
|---------------------------|------------|
| Noise Source .....        | HP 346C    |
| Mixer .....               | 0955-0307  |
| Synthesized Sweeper ..... | HP 8340A/B |
| Noise Figure Meter .....  | HP 8970A/B |
| Amplifier .....           | HP 8449B   |



**Adapters**

|   |           |
|---|-----------|
| APC 3.5 (f) to N (m) .....                    | 1250-1744 |
| APC 3.5 (m) to APC 3.5 (m) .....              | 1250-1748 |
| APC 3.5 (f) to APC 3.5 (f) (3 required) ..... | 5061-5311 |

**Test Procedure Using the HP 8340A/B**

**Note**



If you are using an **HP 8970A Noise Figure Meter**, perform steps 1 through 5, then 9 through 11. If you are using an **HP 8970B Noise Figure Meter**, perform step 1, then 6 through 11.

The noise source data must be loaded into the noise figure meter prior to running the test.

**Using the HP 8970A Noise Figure Meter**

1. Connect the test equipment as shown by the solid lines in Figure 4-2. Do not connect the HP 8449A or HP 8449B at this time.
2. On the HP 8340A/B Synthesized Sweeper, set the power level to the following value:  
 HP 8340A/B ..... 0 dBm
3. To use an HP 8970A, press **PRESET** and wait until the preset process is complete before continuing.
4. On the noise figure meter enter the following special function values:
  - a. 4.1 **SPECIAL FUNCTION** ..... Establishes external LO control.
  - b. 40.1 **SPECIAL FUNCTION** 19 **ENTER** ..... Checks the HP-IB.
  - c. 1.1 **SPECIAL FUNCTION** ..... Establishes external mixer mode.
  - d. 3.0 **SPECIAL FUNCTION** 20 **ENTER** ..... Sets IF = 20 MHz.
  - e. 42.3 **SPECIAL FUNCTION** 10 **ENTER** ..... Sets LO source minimum frequency.
  - f. 42.4 **SPECIAL FUNCTION** 26500 **ENTER** . Establishes external mixer maximum frequency.
  - g.
    - For testing an **HP 8449A**:
      - START FREQ** 2000 **ENTER** ..... Sets start frequency to 2.0 GHz.
      - STOP FREQ** 22000 **ENTER** ..... Sets stop frequency to 22.0 GHz.
    - For testing the **HP 8449B**:
      - START FREQ** 1000 **ENTER** ..... Sets start frequency to 1.0 GHz.
      - STOP FREQ** 26500 **ENTER** ..... Sets stop frequency to 26.5 GHz.
  - h. **STEP SIZE** 500 **ENTER** ..... Increment in 500 MHz steps.
  - i. Use INCREASE or DECREASE to set smoothing = 16.
  - j. Press **CALIBRATE** to calibrate the full range.

## Noise Figure Test

### Note



At this time E27 may appear to warn you about the low frequency issue mentioned at the beginning of this procedure. The HP 8340A/B may completely test the preamplifier below 2.5 GHz if accumulated noise does not prove to be substantial.

If E22 appears after the preamplifier is connected in the circuit and during the testing, choose one of the solutions provided below:

- a. If you are testing for frequencies above 22 GHz, replace the test setup mixer with another mixer.
- b. If you are testing frequencies below 2.5 GHz, refer to the Alternate Noise Figure Test.

5. If E22 occurred while testing below 2.5 GHz, limit the test frequency of the HP 8340A/B to above 2.5 GHz. Set the **(START FREQ)** on the HP 8970A to one of the following values:

**(START FREQ)** 2500 **(ENTER)** ..... For 2.5 GHz

OR

**(START FREQ)** 3000 **(ENTER)** ..... For 3 GHz

## Using an HP 8970B Noise Figure Meter

6. Press **(PRESET)** on the HP 8970B and wait until the preset process is complete before continuing.
7. On the HP 8970B Noise Figure Meter enter the following special function values:
  - a. 0.9 **(SPECIAL FUNCTION)** ..... Presets and loads default parameters.
  - b. 41.4 **(SPECIAL FUNCTION)** ..... Selects HP 8340A/B source.
  - c. 40.1 **(SPECIAL FUNCTION)** 19 **(ENTER)** . Sets the HP-IB address for the HP 8340A. Replace 19 with the HP8340B HP-IB address if it is different.
  - d. 42.3 **(SPECIAL FUNCTION)** 10 **(ENTER)** ..... Sets LO source minimum frequency.
  - e. 42.4 **(SPECIAL FUNCTION)** 26500 **(ENTER)** ..... Sets source maximum frequency.
  - f. 42.5 **(SPECIAL FUNCTION)** 0 **(ENTER)** ..... Sets the power level.
  - g. 1.1 **(SPECIAL FUNCTION)** ..... Establishes external mixer mode.
  - h. 3.0 **(SPECIAL FUNCTION)** 20 **(ENTER)** ..... Sets IF = 20 MHz.

### Note



The start and stop frequencies are different for the HP 8449A and HP 8449B. Set your instrument accordingly.

i.

For testing an **HP 8449A**:

**(START FREQ)** 2000 **(ENTER)** ..... Sets start frequency to 2.0 GHz.

**(STOP FREQ)** 22000 **(ENTER)** ..... Sets stop frequency to 22.0 GHz.

For testing the **HP 8449B**:

- START FREQ** 1000 **ENTER** .....Sets start frequency to 1.0 GHz.
- STOP FREQ** 26500 **ENTER** ..... Sets stop frequency to 26.5 GHz.

- j. **STEP SIZE** 500 **ENTER** .....Increment in 500 MHz steps.
- k. Use **INCREASE** or **DECREASE** to set smoothing = 16.
- l. Press **CALIBRATE** **CALIBRATE** to calibrate the full range.

**Note**



At this time E27 may appear to warn you about the low frequency issue mentioned at the beginning of this procedure. The HP 8340A/B may completely test the preamplifier below 2.5 GHz if accumulated noise does not prove to be substantial.

If E22 appears after the preamplifier is connected in the circuit and during the testing, choose one of the solutions provided below:

- a. If you are testing for frequencies above 22 GHz, replace the test setup mixer with another mixer.
- b. If you are testing frequencies below 2.5 GHz, refer to the Alternate Noise Figure Test.

- 8. If E22 occurred while testing at less than 2.5 GHz, limit the test frequency of the HP 8340A/B to above 2.5 GHz. Set the **START FREQ** on the HP 8970A to one of the following values:

**START FREQ** 2500 **ENTER** ..... For 2.5 GHz  
OR

**START FREQ** 3000 **ENTER** ..... For 3 GHz

- 9. If E22 occurred while testing at greater than 2.5 GHz and in spite of increasing the output power to the mixer, exchange the mixer for another part number 0955-0307.
- 10. When calibration is finished, make the following connections as illustrated with dashed lines in Figure 4-2.
  - a. Disconnect the mixer from the noise source and connect the noise source to the preamplifier INPUT.
  - b. Connect the R port of the mixer to the preamplifier OUTPUT.

If you prefer, break the noise figure test into the three frequency ranges when testing the HP 8449B Preamplifier. Otherwise, skip to step 12.

- 11. Before beginning this portion of the test procedure, enter the frequency range into the HP 8970A/B Noise Figure Meter before testing each range:

a. For range 1:

- START FREQ** 1000 **ENTER** .....Sets start frequency to 1.0 GHz.
- STOP FREQ** 12500 **ENTER** ..... Sets stop frequency to 12.5 GHz.

## Noise Figure Test

b. For range 2:

**START FREQ** 12500 **ENTER** .....Sets start frequency to 12.5 GHz.  
**STOP FREQ** 22000 **ENTER** ..... Sets stop frequency to 22.0 GHz.

c. For range 3:

**START FREQ** 22000 **ENTER** .....Sets start frequency to 22.0 GHz.  
**STOP FREQ** 26500 **ENTER** ..... Sets stop frequency to 26.5 GHz.

12. On the HP 8970A/B, press **NOISE FIGURE AND GAIN**, then **SINGLE**.
13. Watch as the measurement steps through the frequencies. The noise figure is displayed for each step.  
Record the maximum noise figure on Table 4-2.
14. If desired, press **SINGLE** again to review readings.
15. If frequency ranges are being tested, repeat steps 11 through 15 for the remaining range(s).

## Alternate Noise Figure Test

Using HP 8663A Synthesized Signal Generator

### Description

This test measures the noise figure of the preamplifier **below 2.5 GHz**. First, the source and noise figure meter are connected to calibrate the test setup without the preamplifier in the circuit. The preamplifier is then added to the circuit and the noise figure is measured. The test setup is illustrated in Figure 4-3.

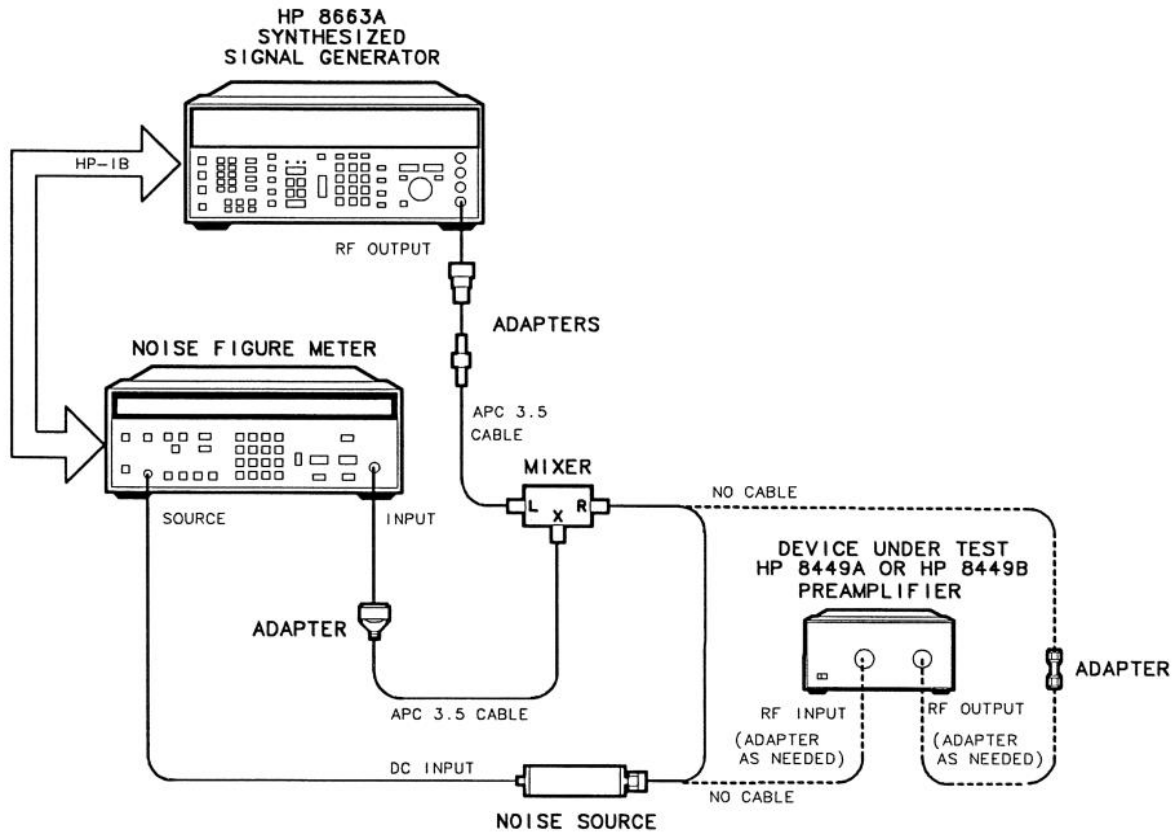

Figure 4-3. Alternate Noise Figure Test Setup for <2.5 GHz

### Recommended Equipment

|                                    |                      |
|------------------------------------|----------------------|
| Noise Source .....                 | HP 346C              |
| Mixer .....                        | Mini-Circuits ZFM-15 |
| Synthesized Signal Generator ..... | HP 8663A             |
| Noise Figure Meter .....           | HP 8970A/B           |

### Adapters

|   |           |
|---|-----------|
| APC 3.5 (f) to N (m) .....                    | 1250-1744 |
| APC 3.5 (m) to APC 3.5 (m) .....              | 1250-1748 |
| APC 3.5 (f) to APC 3.5 (f) (3 required) ..... | 5061-5311 |

## Alternate Noise Figure Test

### Test Procedure Using the HP 8663A

1. Connect test equipment indicated by the solid lines in Figure 4-3. Do not connect the HP 8449A or HP 8448B Preamplifier at this time.

#### Note



If you are using an **HP 8970A Noise Figure Meter**, perform steps 2 through 4, then 6 through 9. If you are using an **HP 8970B Noise Figure Meter**, perform steps 5 through 9.

The noise source data must be loaded into the noise figure meter prior to running the test.

### Using an HP 8970A Noise Figure Meter

2. On the HP 8663A Synthesized Signal Generator, set the power level to +8 dBm.
3. If you are using an HP 8970A Noise Figure Meter, press **PRESET** and wait until the preset process is complete before continuing.
4. On the noise figure meter enter the following special function values:
  - a. 4.1 **SPECIAL FUNCTION** ..... Sets the instrument for external LO control.
  - b. 40.1 **SPECIAL FUNCTION** 25 **ENTER** ..... Sets the HP-IB address. Replace 25 with the HP 8663A HP-IB address if it is different.
  - c. 42.1 **SPECIAL FUNCTION** 70 **ENTER** 82 **ENTER** 77 **ENTER** 90 **ENTER** ... Loads frequency codes of FR and MZ.
  - d. 42.2 **SPECIAL FUNCTION** 40 **ENTER** ..... Sets the settling time to 40 ms.
  - e. 42.3 **SPECIAL FUNCTION** 1 **ENTER** ..... Sets source minimum frequency.
  - f. 42.4 **SPECIAL FUNCTION** 2560 **ENTER** ..... Sets source maximum frequency.
  - g. 1.1 **SPECIAL FUNCTION** ..... Sets external mixer mode.
  - h. 3.0 **SPECIAL FUNCTION** 20 **ENTER** ..... Sets IF = 20 MHz.
  - i.

#### For the HP 8449A:

**START FREQ** 2000 **ENTER** ..... Sets start frequency to 2.0 GHz.

#### For the HP 8449B:

**START FREQ** 1000 **ENTER** ..... Sets start frequency to 1.0 GHz.

- j. **STOP FREQ** 2500 **ENTER** ..... Sets stop frequency to 2.5 GHz.
- k. **STEP SIZE** 500 **ENTER** ..... Increment in 500 MHz steps.
- l. Use INCREASE or DECREASE to set smoothing = 16.
- m. Press **CALIBRATE** to calibrate the full range.

**Using an HP 8970B Noise Figure Meter**

5. If you are using an HP 8970B Noise Figure Meter, press **PRESET** and wait until the preset process is complete before continuing.
  - a. 0.9 **SPECIAL FUNCTION** ..... Presets and loads default parameters.
  - b. 41.5 **SPECIAL FUNCTION** ..... Selects a custom source.
  - c. 40.1 **SPECIAL FUNCTION** 25 **ENTER** ..... Sets the HP-IB address. Replace 25 with the HP 8663A HP-IB address if it is different.
  - d. 42.3 **SPECIAL FUNCTION** 1 **ENTER** ..... Sets LO source minimum frequency.
  - e. 42.4 **SPECIAL FUNCTION** 2560 **ENTER** ..... Sets source maximum frequency.
  - f. 42.5 **SPECIAL FUNCTION** 8 **ENTER** ..... Sets the power level to +8 dBm.
  - g. 42.6 **SPECIAL FUNCTION** 2 **ENTER** 65 **ENTER** 80 **ENTER** 3 **ENTER** 68 **ENTER** 77 **ENTER**
  - h. 59 **ENTER** ..... Sets power control codes to AP and DM;.
  - i. 42.7 **SPECIAL FUNCTION** 2 **ENTER** 70 **ENTER** 82 **ENTER** 3 **ENTER** 77 **ENTER** 90 **ENTER** 59 **ENTER** ..... Sets power codes to FR and MZ;.
  - j. 1.1 **SPECIAL FUNCTION** ..... Sets external mixer mode.
  - k. 3.0 **SPECIAL FUNCTION** 20 **ENTER** ..... Sets IF = 20 MHz.
  - l.

**For the HP 8449A:**

**START FREQ** 2000 **ENTER** ..... Sets start frequency to 2.0 GHz.

**For the HP 8449B:**

**START FREQ** 1000 **ENTER** ..... Sets start frequency to 1.0 GHz.

- m. **STOP FREQ** 2500 **ENTER** ..... Sets stop frequency to 2.5 GHz.
  - n. **STEP SIZE** 500 **ENTER** ..... Increment in 500 MHz steps.
  - o. Use INCREASE or DECREASE to set smoothing = 16.
  - p. Press **CALIBRATE** **CALIBRATE** to calibrate the full range.
6. When calibration is finished, make the following connections illustrated with dashed lines in Figure 4-3.
    - a. Disconnect the noise source from the mixer. Connect noise source to the preamplifier INPUT.
    - b. Connect the R port of the mixer to the preamplifier OUTPUT.

**Note**



If E22 appears after the preamplifier is connected in the circuit and during testing, try increasing the source output power or exchange the test setup mixer for another mixer or Mini-Circuits ZFM-15 mixer.

7. On the noise figure meter, press **NOISE FIGURE AND GAIN** then **SINGLE**.

### **Alternate Noise Figure Test**

8. Watch the measurements step in frequency. The noise figure is displayed for each step. Record the maximum noise figure in Table 4-2.
9. If desired, press **SINGLE** again to review readings.



**Test Results**

**Table 4-2. Performance Test Record (1 of 3)**

|   |                     |                           |                     |
|---|---------------------|---------------------------|---------------------|
| Calibration Entity:                           |                     | Report No. _____          |                     |
| _____   |                     | Date _____                |                     |
| _____   |                     | (such as 10 SEP 1989)     |                     |
| _____   |                     |                           |                     |
| Model Number _____                            |                     |                           |                     |
| Serial Number _____                           |                     |                           |                     |
| Options _____                                 |                     |                           |                     |
| Customer _____                                |                     | Tested by _____           |                     |
| Ambient temperature _____ °C                  |                     | Relative humidity _____ % |                     |
| Power mains line frequency _____ Hz (nominal) |                     |                           |                     |
| <b>Test Equipment Used:</b>                   |                     |                           |                     |
| <b>Description</b>                            | <b>Model Number</b> | <b>Trace Number</b>       | <b>Cal Due Date</b> |
| Noise Source                                  | _____               | _____                     | _____               |
| Synthesized Sweeper                           | _____               | _____                     | _____               |
| Synthesized Signal Generator                  | _____               | _____                     | _____               |
| Scalar Network Analyzer                       | _____               | _____                     | _____               |
| Amplifier                                     | _____               | _____                     | _____               |
| Noise Figure Meter                            | _____               | _____                     | _____               |
| Detectors                                     | _____               | _____                     | _____               |
| Power Splitter                                | _____               | _____                     | _____               |
| Mixer (26 GHz)                                | _____               | _____                     | _____               |
| Mixer (3 GHz)                                 | _____               | _____                     | _____               |
| Special Notes:                                |                     |                           |                     |
| _____   |                     |                           |                     |
| _____   |                     |                           |                     |

**Alternate Noise Figure Test**

**Table 4-2. Performance Test Record for HP 8449A (2 of 3)**

|                       |                  |
|-----------------------|------------------|
| Model <b>HP 8449A</b> | Report No. _____ |
| Serial No. _____      | Date _____       |

| Test No. | Test Description         | Results |          |         | Measurement Uncertainty |
|----------|--------------------------|---------|----------|---------|-------------------------|
|          |                          | Min.    | Measured | Max.    |                         |
| 1.       | Gain and Flatness Test   | 23 dB   |          | 7.6 dB  | ±0.7 dB *               |
|          | Mimumum Gain             |         | _____    |         |                         |
|          | Flatness (max variation) |         | _____    |         | ±0.7 dB *               |
| 2.       | Noise Figure Test        |         | _____    | 12.5 dB | ±0.56 dB                |

\* Measurement uncertainty is ±0.4 dB below 12.5 GHz.

**Table 4-2. Performance Test Record for HP 8449B (3 of 3)**

|                  |                  |
|------------------|------------------|
| Model HP 8449B   | Report No. _____ |
| Serial No. _____ | Date _____       |

| Test No.  | Test Description         | Results |          |         | Measurement Uncertainty |
|---|--------------------------|---------|----------|---------|-------------------------|
|   |                          | Min.    | Measured | Max.    |                         |
| 1.  | Gain and Flatness Test   | 23 dB   | _____    | 11.4 dB | ±0.7 dB *               |
|   | Mimimum Gain             |         | _____    |         | ±0.7 dB *               |
| 2.  | Flatness (max variation) |         | _____    |         |                         |
|   | Noise Figure Test        |         | _____    |         |                         |
|   | 1.0 to 12.5 GHz          |         | _____    | 8.5 dB  | ±0.56 dB                |
|   | 12.5 to 22.0 GHz         |         | _____    | 12.5 dB | ±0.56 dB                |
|   | 22.0 to 26.5 GHz         |         | _____    | 14.5 dB | ±0.56 dB                |
| * Measurement uncertainty is ±0.4 dB below 12.5 GHz |                          |         |          |         |                         |



## Replaceable Parts

---

### Introduction

This chapter provides information on identifying and ordering all replacement parts and assemblies. The replaceable parts are listed in Table 5-1 and their locations are identified in Figure 5-1.

---

### Parts List

The following information is listed in Table 5-1 for each part.

1. Reference Designator.
2. The Hewlett-Packard part number.
3. The part number check digit (CD).
4. The total quantity (Qty) in the assembly.
5. The description of the part.

### Replaceable Parts

| Reference Designator | HP Part Number | CD | Qty | Description                                    |
|----------------------|----------------|----|-----|--|
| A1                   | 5086-7805      | 4  | 1   | Amplifier, 1 to 26.5 GHz                       |
| A2                   | 0950-2102      | 2  | 1   | Power Supply, +6 V, and -5 V                   |
| FL1                  | 08449-60001    | 4  | 1   | Line Module and On/Off Switch Assembly         |
| FL1MP1               | 9135-0248      | 4  | 1   | Voltage Selector Drum (p/o 08449-60001)        |
| S1                   | 3101-2025      | 2  | 1   | Switch, Rocker, 2 A, 250 Vac (p/o 08449-60001) |
| DS1                  | 1990-1238      | 8  | 1   | LED, Green, 1.5 MCD                            |
| XDS1                 | 85680-40004    | 4  | 1   | LED Mount                                      |
| FL1F1                | 2110-0202      | 1  | 1   | Fuse, 0.5 A, 250 V, S                          |
| W2                   | 08449-20011    | 8  | 1   | Cable Assembly, Amplifier Out                  |
| W1                   | 08449-20012    | 9  | 1   | Cable Assembly, Amplifier In                   |
| MP1                  | 08449-00010    | 5  | 1   | Chassis, Main                                  |
|                      | 1250-1666      | 8  | 2   | HP 8449A Adapter, SMA (f) to SMA (f)           |
|                      | 08673-60040    | 9  | 2   | HP 8449B Adapter, APC 3.5 (m) to APC 3.5 (f)   |
|                      | 5021-0528      | 6  | 1   | Top Cover                                      |
|                      | 5062-3886      | 3  | 1   | Bottom Cover                                   |
|                      | 5041-8801      | 8  | 4   | Bottom Feet                                    |
|                      | 5021-8413      | 6  | 1   | Front Frame                                    |
|                      | 5021-5814      | 7  | 1   | Rear Frame                                     |

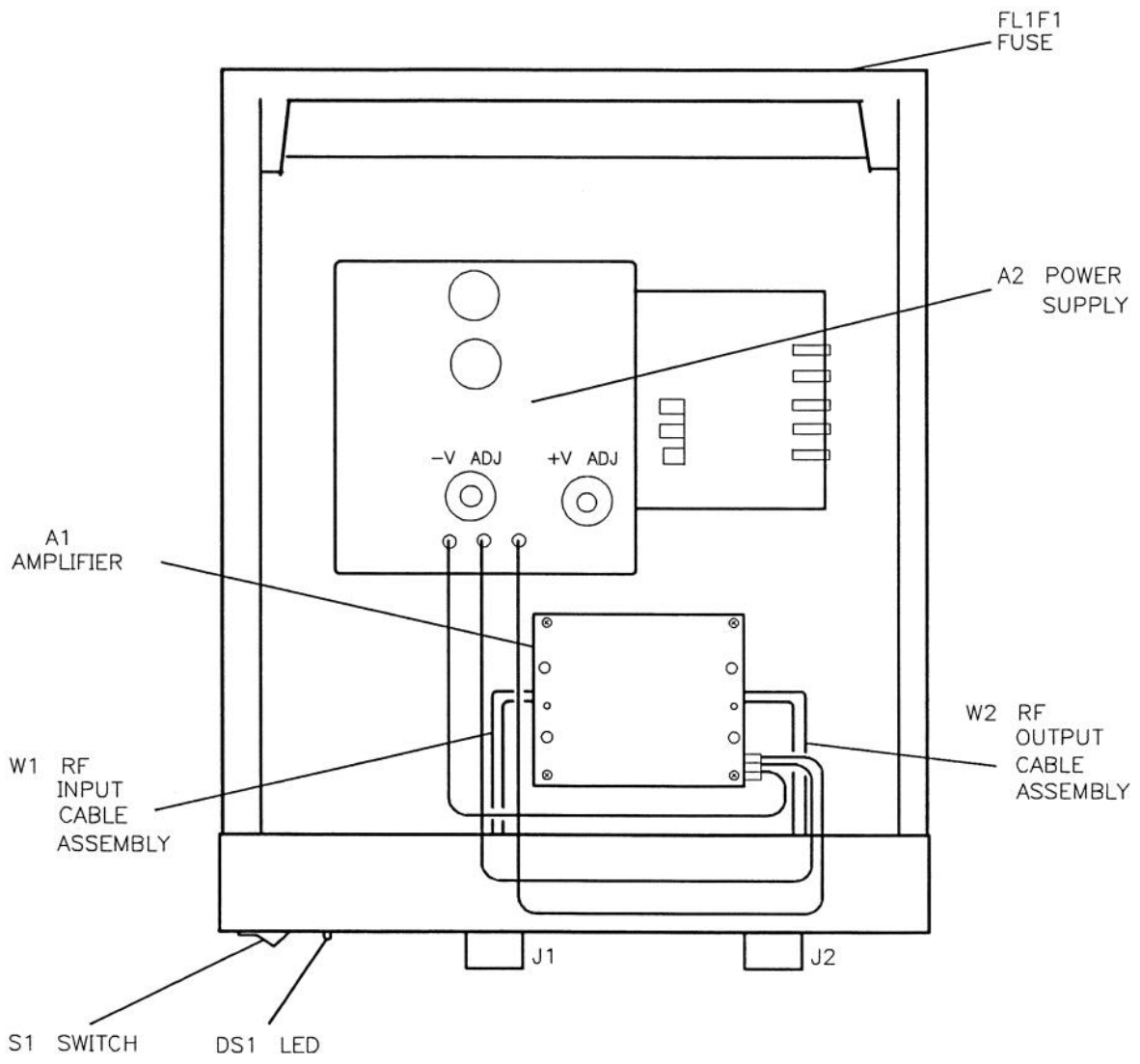

**Figure 5-1. HP 8449A and HP 8449B Parts Locations**

---

## Parts Ordering Information

To order a part or assembly, provide the Hewlett-Packard part number, the check digit, and the quantity required; send the order to the nearest Hewlett-Packard Sales and Service Office. See Table 6-3. The check digit will ensure accurate and timely processing of your order.

To order a part that is not listed in the replaceable parts table, include the preamplifier model number (HP 8449A or HP 8449B), the description and function of the part, and the number of parts required. Send the order to the nearest Hewlett-Packard Sales and Service Office.

### Direct Mail Order System

Within the USA, Hewlett-Packard can supply parts through a direct mail order system. Advantages of using the system are as follows:

- Direct ordering and shipment from the Hewlett-Packard Parts Center.
- No maximum or minimum order on any mail order. (There is a minimum order amount for parts ordered through a local HP office when the orders require billing and invoicing.)
- Prepaid transportation. (There is a small handling charge for each order.)
- No invoices.

To provide these advantages, a check or money order must accompany each order. Mail order forms and specific ordering information are available through your local Hewlett-Packard Sales and Service Office.

### Direct Phone Order System

Within the USA, a phone order system is available for regular and hotline replacement parts service. A toll-free phone number is available, and Mastercard and Visa are accepted.

**Regular Orders**      The toll-free phone number, (800) 227-8164, is available from 6 AM to 5 PM, Pacific time, Monday through Friday. Regular orders have a 4-day delivery time.

**Hotline Orders**      Hotline service for ordering emergency parts is available 24 hours a day, 365 days a year. There is an additional hotline charge to cover the cost of freight and special handling.

The toll-free phone number, (800) 227-8164, is available from 6 AM to 5 PM, Pacific time, Monday through Friday; a separate number, (415) 968-2347, is available after-hours, weekends, and holidays. Hotline orders are normally delivered the following business day.



## Service

---

### Introduction

This chapter provides information about the following items:

- Basic Troubleshooting
- General Troubleshooting
- Testing and Adjusting the Power Supply
- General Maintenance
- Returning the Unit for Service

---

## Check the Basics

A problem can often be solved by rechecking what was being done when the problem occurred. A few minutes spent in performing some simple checks may save time spent waiting for your instrument to be repaired. Before calling Hewlett-Packard or returning the preamplifier for service, please make the following checks:

- Is the preamplifier plugged in to the proper ac power source? Does the line receptacle have power?
- Is the rear-panel voltage selector switch set correctly? Is the line fuse good?
- Is the preamplifier turned on?
- Are the other equipment, cables, and connectors being used with the preamplifier connected properly and operating correctly?
- Review the procedure for the test being performed when the problem appeared. Are all the switch settings correct?
- Are the test results within the specifications and capabilities of the HP 8449A or HP 8449B? (See Chapter 1, Table 1-2 and Table 1-3, for preamplifier specifications and characteristics.)

---

## General Troubleshooting

The HP 8449A and HP 8449B consist of two basic internal elements: the amplifier microcircuit and the power supply. See Figure 6-1. Neither of these elements is considered repairable; each must be replaced as a unit. Use the following tests to determine which element is failing.

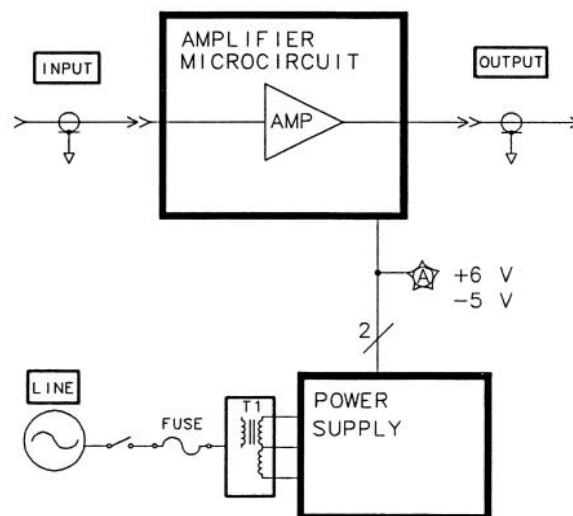

Figure 6-1. HP 8449A and HP 8449B Preamplifier, Block Diagram

## Testing the Amplifier

Perform the performance tests given in Chapter 4. Record all test results. (For a quicker approximation of microcircuit operation, test only the low, high, and mid-frequency levels.) If the performance test results are not within the listed specifications, test power supply operation before replacing the amplifier microcircuit.

## Testing and Adjusting the Power Supply

To test power supply operation, use an HP 3456A Digital Multimeter (or equivalent) to measure the power supply dc output voltages at the amplifier microcircuit. If the voltages are not within tolerance, adjust the power supply.

---

### Warning



**Only trained service personnel should perform measurements inside the instrument chassis. Use extreme care; the exposed terminals on the power supply transformer carry ac line voltage; you can be killed or seriously injured if you contact them when power is applied.**

---

1. Remove the preamplifier top and bottom covers from the chassis.
2. Measure the power supply output voltages on the amplifier microcircuit. See Figure 5-1.
  - The voltage reading on the 6 volt lead should be  $6 \pm 0.1$  V dc.
  - The voltage reading on the  $-5$  volt lead should be  $-5 \pm 0.05$  V dc.
3. If either voltage is incorrect, adjust the power supply as follows:
  - a. On the power supply board, connect the multimeter between the + OUT terminal and ground. Set the +5 V ADJ R9 to read  $+6 \pm 0.1$  V dc.
  - b. On the power supply board, connect the multimeter between the - OUT terminal and ground. Set the - 5 V ADJ R13 for a reading of  $-5 \pm 0.05$  V dc.
4. After adjusting both voltages, repeat step 2. If the power supply output voltage(s) cannot be brought within tolerance, disconnect the power supply lead(s) from the amplifier microcircuit and repeat step 3.
5. If the power supply output voltage(s) still cannot be brought within tolerance, replace the power supply. If the voltage(s) are correct, and the performance test results still are not within specification, replace the amplifier microcircuit.

---

## General Maintenance

### Required Tools

Table 6-1 lists the tools that may be required to remove the preamplifier microcircuit or the power supply from the HP 8449A and HP 8449B.

**Table 6-1. Required Tools**

| Description                  | HP Part Number | Check Digit |
|------------------------------|----------------|-------------|
| Phillips screwdriver #0      | 8710-0978      | 6           |
| Small Pozi-drive screwdriver | 8710-0899      | 0           |
| Large Pozi-drive screwdriver | 8710-0900      | 4           |
| Wire cutter                  | 8710-0012      | 9           |
| Long-nose pliers             | 8710-0030      | 1           |
| 5/16-inch combination wrench | 8720-0015      | 3           |
| 5/8-inch open-end wrench     | 8720-0010      | 8           |
| 7-mm combination wrench      | 8710-1258      | 7           |

### Removal and Replacement of Assemblies

---

**Caution**

This instrument contains static-sensitive components. Read the electrostatic discharge information in Chapter 1 before removing any assemblies.

---

**Caution**

Avoid bending or distorting any semirigid cables when removing or reinstalling assemblies. Before removing an assembly, always loosen both ends of any semirigid cable attached to the assembly. When reinstalling cables, tighten to specified torque only. If a torque-measuring tool is not available, make semirigid cable connections finger-tight only. Do not overtighten! This reduces the chance of cable damage.

---

**Caution**

This instrument contains both metric- and English-sized hardware. Be sure to use the proper tool to avoid damage.

---

Figure 5-1 identifies the replaceable amplifier microcircuit and the power supply. Table 6-2 specifies the tool sizes to use in removing and reinstalling the replaceable assemblies and the associated torque values.

**Table 6-2. Torque Values**

| Description                                  | Tool Size        | Torque         |
|--|------------------|----------------|
| Nut securing INPUT and OUTPUT SMA connectors | 5/16 inch        | 25 inch-pounds |
| SMA cable connections                        | 5/16 inch        | 10 inch-pounds |
| Screws securing amplifier microcircuit       | Small Pozi-drive | 3 inch-pounds  |

---

## Returning Your HP 8449A or HP 8449B to Hewlett-Packard for Service

### Before You Call Hewlett-Packard

The warranty for your HP 8449A or HP 8449B is printed on the inside front cover of this manual. Please read it and become familiar with its terms. If your HP 8449A or HP 8449B is covered by a separate maintenance agreement, please be familiar with its terms.

(Hewlett-Packard offers several optional maintenance plans to service your preamplifier after the warranty has expired. Call your Hewlett-Packard Sales and Service Office for full details.)

### How to Call Hewlett-Packard

Hewlett-Packard has sales and service offices around the world to provide you with complete support for your HP 8449A or HP 8449B. To obtain servicing information or to order replacement parts, contact the nearest Hewlett-Packard Sales and Service Office listed in Table 6-3.

In any correspondence or telephone conversations, refer to the instrument by its model number and full serial number. With this information, the HP representative can quickly determine whether your unit is still within its warranty period.

### Service Tag

If you are returning the preamplifier to Hewlett-Packard for servicing, fill in and attach a blue service tag. Several service tags are supplied at the rear of this manual.

Please be as specific as possible about the nature of the problem. If you have recorded any error messages that appeared on the screen, or have completed a Performance Test Record, or have any other specific data on the performance of the preamplifier, please send a copy of this information with the unit.

### Original Packaging

Before shipping, pack the unit in the original factory packaging materials if they are available. If the original materials were not retained, identical packaging materials are available through any Hewlett-Packard Sales and Service Office. Descriptions of the packaging materials are listed in the legend for Figure 2-1.

## Other Packaging

Equipment damage can result from using packaging materials other than those specified. Never use styrene pellets in any shape as packaging materials. They do not adequately cushion the equipment or prevent it from shifting in the carton. They also can cause equipment damage by generating static electricity.

You can repackage the instrument with commercially available materials, as follows:

1. Attach a completed service tag to the instrument.
2. Protect the control panel with cardboard.
3. Wrap the instrument in antistatic plastic to reduce the possibility of damage caused by electrostatic discharge.
4. Use a strong shipping container. A double-walled, corrugated cardboard carton with 159 kg (350 lb) bursting strength is adequate. The carton must be both large and strong enough to accommodate the preamplifier. Allow at least three to four inches on all sides of the preamplifier for packing material.
5. Surround the equipment with three to four inches of packing material to prevent the equipment from moving in the carton. If packing foam is not available, the best alternative is S.D.-240 Air Cap<sup>TM</sup> from Sealed Air Corporation (Commerce, California, 90001). Air Cap looks like a plastic sheet filled with 1-1/4 inch air bubbles. Use the pink-colored Air Cap to reduce static electricity. Wrapping the equipment several times in this material should both protect the equipment and prevent it from moving in the carton.
6. Seal the shipping container securely with strong nylon adhesive tape.
7. Mark the shipping container **FRAGILE, HANDLE WITH CARE** to assure careful handling.
8. Keep copies of all shipping papers.